



# MGCC B

Technische dag 2020

Afstellen van SU carburatoren



Vacuüm meter

## WHAT IT ALL MEANS

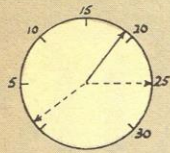

Needle falls sharply on acceleration—means the engine is in good condition

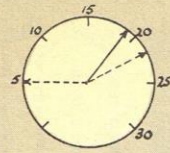

Falls slowly and drifts to normal reading—shows poor condition generally

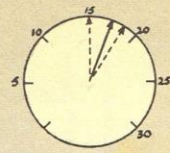

Generally low reading with needle weaving indicates weak mixture or air leak

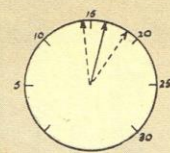

Floating between 15-18 shows too rich mixture, or fault in carb somewhere

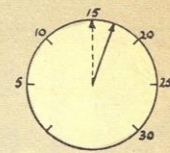

Regular beat could mean a burnt valve or tappet clearances not correct

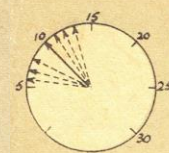

Very unsteady needle means a hot spot plate or heat riser burnt through



Steady needle shows retarded ignition—late valve timing or hot spot fault

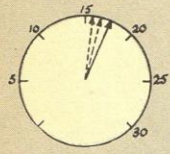

Needle tremors—means the tappets are out of adjustment, don't confuse ...

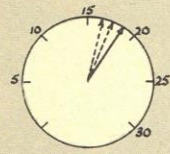

... with this reading, which means faults at the plugs, points or distributor

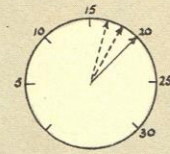

An irregular drop could mean gummed-up valve stems or a faulty plug action

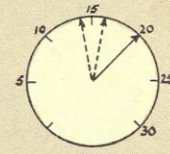

On the other hand, an irregular kick in the needle means a sticking valve

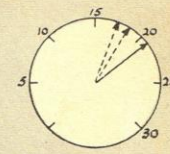

A kick to a high reading could mean over-advanced timing, or condenser fault

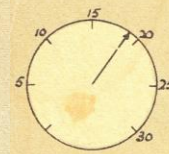

This is normal reading at steady tickover—Redex treatment will improve this

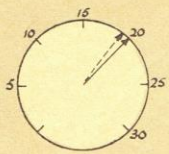

Short out plugs—needle should drop evenly, if not there's plug or cylinder fault

### HOW TO FIT A VAC GAUGE

**First:** Drill hole through manifold in appropriate position. Weber carburettor has convenient position at servo take-off. Grease drill tip to prevent swarf forming

A 2BA tap, not supplied with the kit, will provide thread for adaptor (provided). It is best to drill at right angles, but not absolutely necessary. Do keep the tap steady

Push plastic piping on to the adaptor. With twin carbs, the pipe is connected to a T-piece and two adaptors are tapped in. Do not drill above the level of the butterfly

Other end of pipe connects to gauge. A screw damper steadies gauge needle and makes reading easier. Dip pipe in hot water to make pliable before you fit it

Chris Drake tells how to fix faults by dial

# DIAL TUNE

► The vacuum gauge is perhaps the most "understood" of all dashboard instruments. But in actual fact it does three extremely important jobs: aids economical driving; tells you how your engine is performing; and diagnoses faults in the electrical, mechanical and fuel systems.

We found out more about it when we took a staff car along to Redex Ltd, at 365 Chiswick High Road, London, W.4, to have one fitted. In very brief terms the vacuum gauge diagnoses engine efficiency by measuring the amount of vacuum in the inlet manifold at the various engine speeds. The vacuum inside the manifold alters with every change in carburation, ignition, and engine condition. The movements of pistons, valves, etc., also have

an effect on the vacuum, and it is these which are recorded by the gauge. The instrument is usually fitted in a convenient position on the fascia panel, where it can be seen clearly and without taking your hands off the steering wheel.

If you're driving for economy then the needle on the gauge should be kept as high as possible. For instance, over-acceleration will cause the needle to swing over to near the zero mark. Ease off the right foot—you won't lose much speed and the amount of petrol saved will more than compensate. It does, actually, give you a much better idea of how to "feather-foot" on the accelerator pedal.

I have set out 14 possible readings at the top of the page, so there is no point in going into detail about fault diagnosis.

However, it might be a good

idea to explain in a little detail how to check on sparking plug condition, ignition timing and other settings, such as carburettor adjustments.

**Sparking plugs:** Set the throttle to a fast tickover and short out each plug in turn with a screwdriver. A well-tuned and balanced engine should show an even drop on all cylinders.

**Ignition timing:** Before setting the ignition timing, be sure that the vacuum advance control is connected. Now increase the engine speed until the ignition warning light goes out. Slightly richen the petrol mixture and then loosen the distributor clamp bolt. Retard ignition until the needle on the vacuum gauge falls (note: turning the distributor in the opposite direction of the rotor arm will advance ignition) and then slowly rotate the distributor in the opposite direction

until the needle on the gauge "kicks". Now, carefully retard ignition until needle is steady. Finally retard it by a further ¼ HG and tighten clamp.

**Carburettor:** First clean thoroughly. Adjustment is at normal tickover speed. On SUs you should disconnect the choke wire or rod before adjusting jet position. On the other hand, twin and triple carb layouts are catered for by special instructions that come with the Redex kit. When the carb or carbs are connected to the gauge, close all the controls completely before adjusting. The technique is to open the controls gradually until they run evenly. Second step is to adjust the mixture control to obtain the highest steady reading.

If the needle on the gauge persists in "shaking" after you have checked the carb settings, sparking plugs and ignition

timing, then the cb points should be checked for gap and pitting. Lubricate the distributor weights and springs while in the process of adjusting distributor points.

There's really no end to the usefulness of the vacuum gauge! A choked exhaust system, for instance, will cause the needle to recover gradually—as pressure is built up in the system.

**Compression testing:** With the throttle completely closed and engine switched off, operate the starter on the solenoid. If all four/six/eight cylinders are perfectly balanced, then the needle will rise to a steady reading of about 15. If the reading is steady but low, this indicates an air leak somewhere.

The Car Care Robot, which you can fit yourself in well under an hour, costs £2 9s. Od., and 10s. Od. extra if you want an illuminated dial.

## 8 TYPICAL READINGS

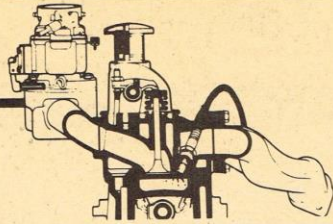
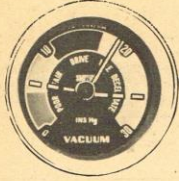

1

Depending on the engine, a normal vacuum gauge reading is 18-20 in. of mercury. If you suddenly open and close the throttle, the needle should fall sharply back to zero and quickly flick back to 25 before settling at normal. If the needle climbs back to the normal position very slowly, look for any form of blockage in the exhaust system.

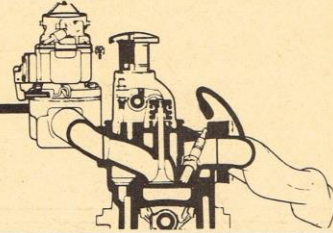
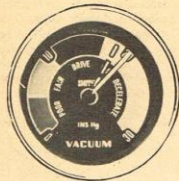

2

By disconnecting each plug in turn, spark plugs can be checked. As each plug on a four-cylinder engine is disconnected, vacuum should drop  $1\frac{1}{2}$  or 2 in. The drop is  $\frac{3}{4}$ - $1\frac{1}{2}$  in. on six-cylinder engines. If disconnecting a plug doesn't produce a drop, either the plug is faulty or the HT lead is shorting. It can also indicate that there is an exhaust valve burned.

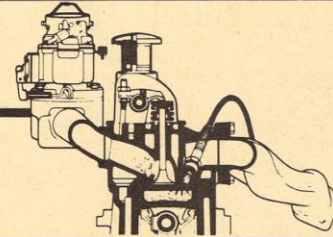
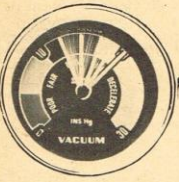

3

An irregular kick-down of the needle may be caused by a leaking inlet valve—a poor seating or too tight a tappet clearance. The fluctuation is caused by the small gas leak into the inlet manifold when the affected cylinder is on the firing stroke. This is detected by the gauge. To double check this you should use a compression tester to check the various cylinder readings.

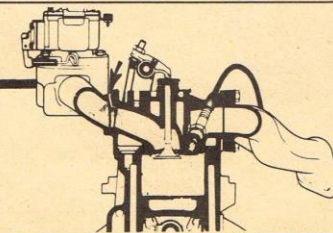
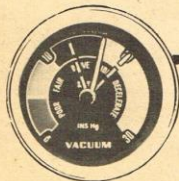

4

At a low vacuum reading—say at around 15-18 in.—the needle may float or weave. If the instrument is properly set up and the carburettor jets are right, check for an air leak at the carburettor flange, and for leakage at the manifold gasket. A distorted flange can be trued up with a flat file providing you do the work carefully.

# VACUUM GAUGES

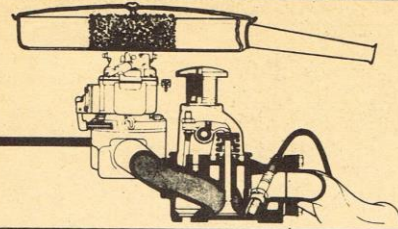
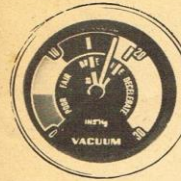

5

A regular float of the needle and a low vacuum reading, between 14 and 18 in., approximately, indicates too rich a mixture. Two common causes are a blockage in the carburettor air cleaner, or a choke control that is sticking. Other possible causes are a leaking float chamber needle valve, punctured float or (on SU or Stromberg CD) a wrong needle.

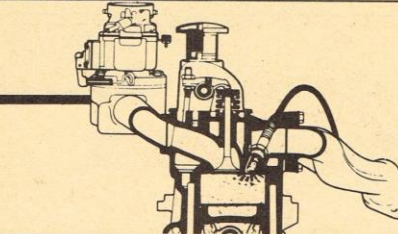
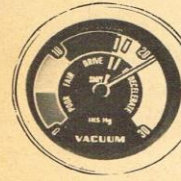

6

Over-advanced ignition is indicated by high vacuum and an irregular kick-down. The gauge can be used to reset this. Simply speed up the engine slightly and loosen the distributor clamp. Then turn the distributor in the "retard" direction until the needle drops  $\frac{1}{2}$ -1 in. approx. on the scale from the point at which the original kick-back had been occurring.

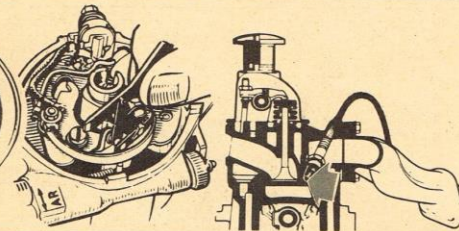
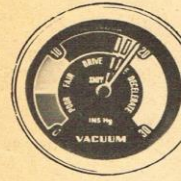

7

If the needle shows normal vacuum but gives an occasional kick-down, the chances are that the trouble is in the ignition system. Check the plugs—the gaps may be too close—and also check the contact breaker points. These could be pitted or mal-adjusted. If there is also a rattle from the distributor the advance springs may be loose.

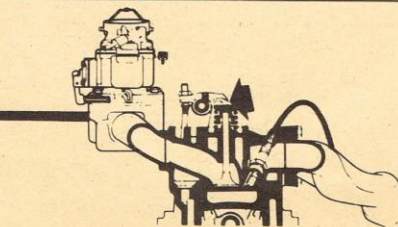
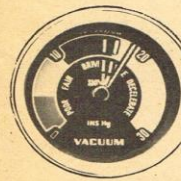

8

If the needle trembles and the vacuum is slightly low you can be sure that the tappets are out of adjustment. Before trying to re-set them, check if the manufacturer advises setting them with the engine hot, cold, or running. For "hot" settings the engine should be run for half an hour. For "cold" settings it must stand overnight. If it's "running"—go straight ahead.

'S a versatile instrument, the vacuum-gauge. Although most drivers who fit one tend to use it only as a petrol-saver, it will in fact diagnose defects the engine's "breathing": show you if the ignition is maladjusted; tell you the valves are faulty; and help you set your carburettor. Not only that—it is also relatively inexpensive and easy to fit. Simply connect the gauge in the car to the tapping in the inlet manifold by a length of pipe. That means drilling and tapping one hole—preferably so that the tube runs from the top of the manifold, to exclude unburned fuel—and fixing the gauge where you can read it while driving.

After that, you can use it all the time. If optimum fuel consumption is what you are after, just drive so that you get the highest possible reading. And for fault diagnosis, keep an eye on it and interpret the readings. To enable you to do this we've taken eight typical examples and have set out not just to show you what they mean, but what is actually happening inside the engine. These are based on a tickover vacuum of 20 in. Some engines—particularly the high-performance units—may have a lower tickover figure than this. All you have to do in such a case is to reduce the readings we have shown proportionately, and they will then apply to your engine as well.

# SMITHS Vacuum/Performance Gauges

This is a sensitive instrument designed to record the difference in pressure between the outside atmosphere and the intake manifold. The lower pressures in the manifold are usually referred to as a "vacuum". The vacuum gauge is useful for tuning engines and locating troubles which originate in the induction systems of the engine. One of their most popular uses is to make a correct setting of the idling mixture.

The instrument is simple to fit. If there is a vacuum "take off" point in existence on the inlet manifold then this may be used, i.e. if the car is fitted with a vacuum servo for the brakes then a 'T' piece may be fitted to the feed pipe of the vacuum servo, this should be fitted as near to the manifold as possible. If there is no "take off" point then the manifold will have to be drilled and tapped and the hose connector fitted.

Before any tests are carried out the engine should be thoroughly warmed.

At tickover the pointer should be steady with a reading between 17" and 21" of vacuum, depending on the type of engine. At high altitudes, the readings will drop and be somewhat less. The difference is in the region of 1" for every 1,000 feet of altitude.

Be careful not to jump to hasty conclusions. A low steady reading may indicate uniformly poor compression (which can be checked with a compression gauge) but it could also indicate faulty carburation or retarded ignition setting. It is therefore wise to check each possible fault independently, before arriving at the final diagnosis of the trouble.

The popular use of a vacuum gauge is to check suspect carburettor settings. This is easily done. Adjust the carburettor to give a normal idling speed, then adjust the mixture until a maximum vacuum reading is obtained on the gauge. With a carburettor in good condition, this operation will improve the petrol economy of the car and prevent either lean or rich mixtures and their resulting ill-effects on the engine.

When an engine is running at a steady speed, the pointer should be constant. However, when the throttle is "blipped" open and closed quickly, the pointer should drop to 2 and return to 25. A low but uniform dial reading usually means that the piston rings are faulty but it could also be leaking valves, incorrect mixture or wrong ignition timing. To confirm a worn piston ring, "blip" the throttle. The readings should drop to zero and return to about 22.

When the pointer drops occasionally from 3 to 5, suspect a sticking or a burned valve. If the pointer trembles then loose valve guides are a possible cause. When the engine is racing and the pointer swings slowly back and forth, weak valve springs may be the cause. If the gauge pointer drifts slowly between 14 and 16, resetting the plug gaps should cure it. If not, try resetting the contact breaker points. If the gauge reading is normal when the engine is first started but the hand slowly drops back after some minutes, check the exhaust pipe and silencer for blockages.

Before attempting a vacuum test, it is wise to clean and reset plug gaps and also to check ignition contact points and timing. If these are correct then one common source of faults is eliminated and the field of errors narrowed.

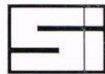

**SMITHS INDUSTRIES LIMITED**

**MOTOR ACCESSORY DIVISION**

**SALES & SERVICE · OXGATE LANE · LONDON · NW2**

Telephone: 01-452 3333 Telex: 22671 Telegrams: Speedofac, London

BRISTOL: 129 Albert Road, BS2 OYE Telephone: Bristol 70314/5

GLASGOW: 123-145 North Street, C3 Telephone: 041-221 3972

MANCHESTER: 780 Chester Road, Stretford Telephone: 061-865 2414

BELFAST: 19 Ormeau Avenue Telephone: Belfast 32911

DEPOTS:

# Engine Fault Analysis · Using a SMITHS Performance Gauge / Vacuum Gauge



**1** An engine in good condition should have a reading of 17 to 21 and hand should be steady. Also study illustration No. 10 and 11.



**2** When opening and closing the throttle quickly, the reading on an engine in good condition should drop to 2 and come back to 25.



**3** A reading lower than normal and with the hand steady indicates that rings are in poor condition.



**4** To confirm a worn ring condition, open and close throttle, reading should drop to zero and come back to about 22.



**5** When the hand drops occasionally from 3 to 5 points, from the normal reading, it generally indicates a sticking valve.



**6** A burned valve will cause the needle to drop back several divisions each time that particular cylinder operates.



**7** Leaking valves also show up on the gauge by the needle dropping back 3 or 4 divisions, whenever the valve operates.



**8** When needle has a fast vibration between approximately 14 and 19 it indicates loose valve guides.



**9** With the engine racing, weak valve springs will cause the gauge needle to swing back and forth. The faster the engine speed the greater the swing.



**10** When gauge needle is steady at about 8 to 14 it generally indicates incorrect valve timing. See also illustration 3, 4 and 11.



**11** A steady low reading of 13 to 16 generally indicates faulty ignition timing or worn piston rings. See also illustrations 3, 4 and 10.

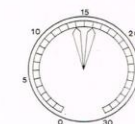

**12** When a needle drifts between 14 and 16 it generally indicates that plug gaps are too close, or breaker points are not properly synchronised.



**13** A steady reading below 5 indicates a leaky manifold gasket or carburettor gasket. Also check heat riser.



**14** When hand drifts regularly between 5 and 19 it is generally caused by a compression leak between cylinders.



**15** A choked silencer will result in a normal reading when the engine is started, but reading will soon drop to between zero and five.

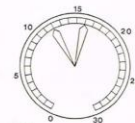

**16** Poor adjustment of the carburettor will cause the needle to float slowly between 12 and 16. See also illustration 12.

SYMPTOM	CAUSE	REMEDY
Erratic running Stalling at idling Lack of power High fuel consumption	Sticking piston Dirty piston and suction chamber Jet out of centre Bent needle	Clean Re-centre Fit new
Too rich at idling Fuel leak	Jet gland leakage Faulty top gland Dirt under top gland washer Faulty bottom gland	Clean Fit new
Float chamber or jet flooding	Incorrect fuel level Dirty or worn float chamber Needle valve Punctured float	Check and reset level Clean or renew valve Fit new

# Fault Diagnosis

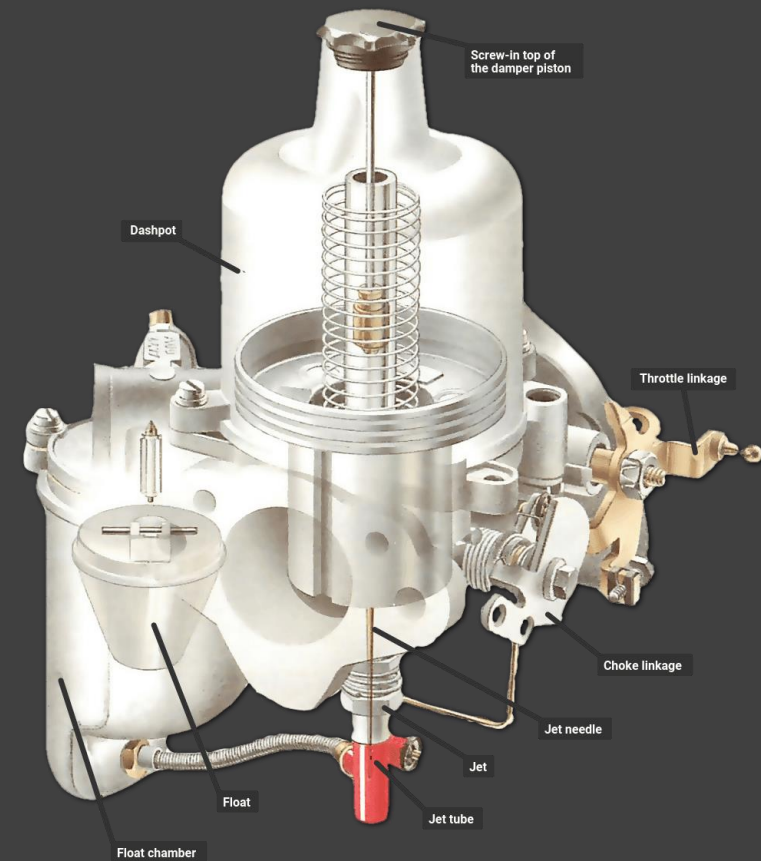



- Use the piston lifting pin at the side of the carburettor to check the fuel-air mixture.
- With the engine running at working temperature, hook your finger under the pin and raise the piston about 1/32in. (1 mm).
- If, while the piston is raised, the engine speed increases briefly then returns to normal, the mixture is correct. If it rises and stays high, the mixture is too rich. If it falls and the engine tends to die, the mixture is too weak.
- To correct the mixture, move the jet adjuster nut one hexagon flat at a time.
- Screwing it up - anti-clockwise as seen from above - makes the mixture weaker.
- Screwing it down - clockwise makes the mixture richer.
- Each time you move the adjuster, wait for about ten seconds, then check again with the lifting pin to see whether the mixture is now right.
- Take care that the engine temperature does not rise above normal - which it will if you take too long.
- Such a rise will result in a false, overweak mixture setting which will show when the temperature returns to normal.
- Before and after adjustment, check that the jet needle is central in the jet.
- Stop the engine, use the damper to lift the piston to the top of its travel and let it drop.
- It should fall smoothly with a sharp click. If it does not, the jet is out of line and you must centralise it.
- An off-centre jet may also score or bend the tapered needle. Do not attempt to clean up or straighten a badly scored or bent needle. It must be replaced (See [Checking and cleaning an SU carburettor](#) ).

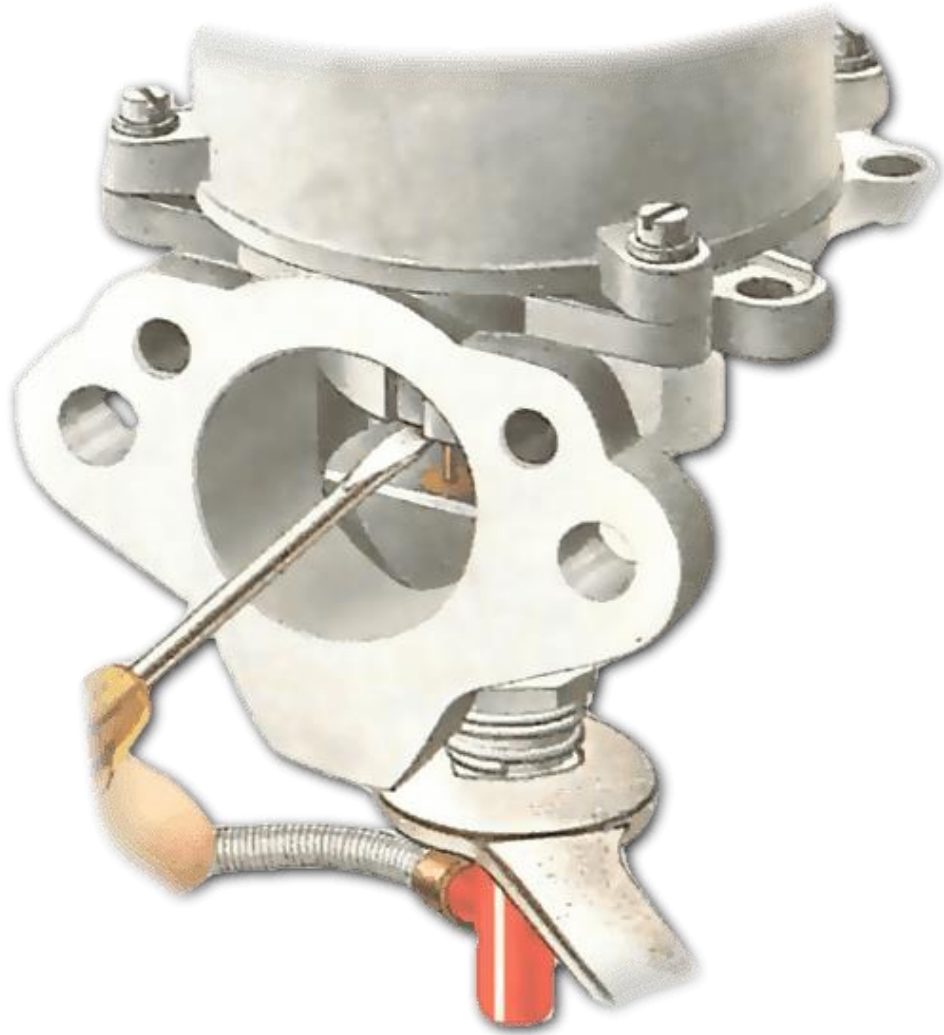

- With the air cleaner off, the piston can be lifted with a screwdriver. The jet should be screwed up as high as the bridge if possible.
- Remove the air cleaner and the dashpot screw-in top and damper. Use a screwdriver to raise the piston.
- Turn the jet adjuster nut up as far as it will go, or until the jet is level with the bridge inside the carburettor.
- Slacken the large locking nut above the adjuster nut on the jet where it enters the carburettor body.



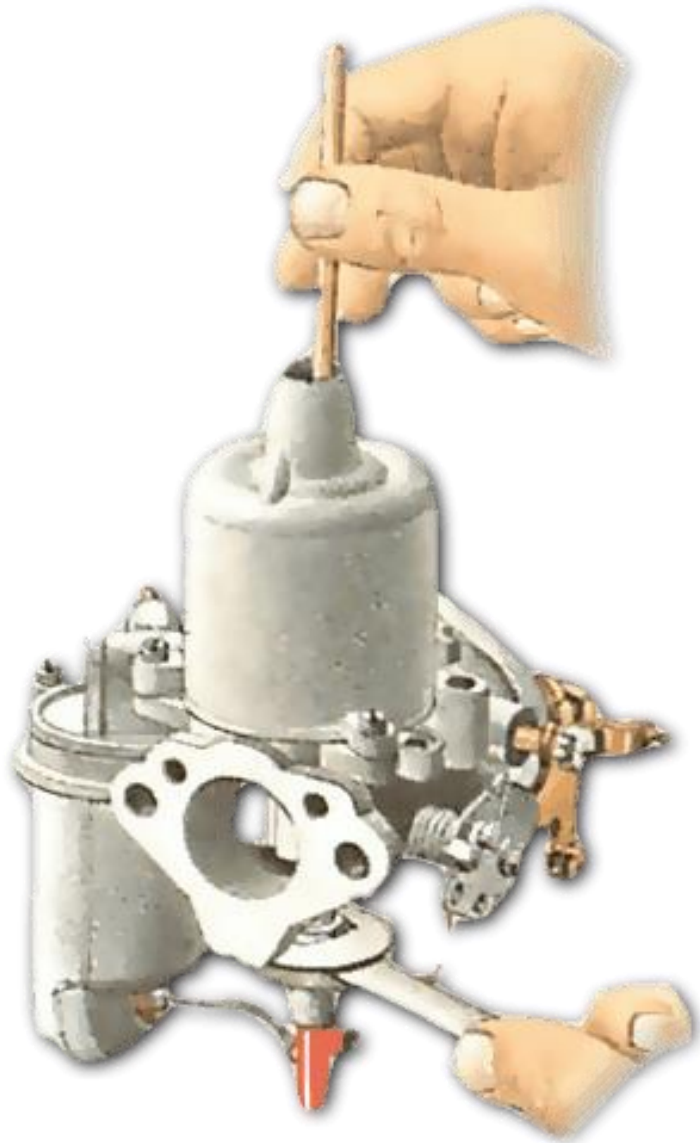

- Hold the piston down with a pencil while you tighten the locking nut.
- Now use a pencil or soft metal rod, such as a stick of solder, to push the piston right down. Hold it down and tighten the locking nut.
- Check that the piston drops with a click - if it does not, repeat the centralising process.
- Screw the jet adjuster nut down two full turns, which should bring it near enough to the correct setting for the engine to

## THE IDIOT'S GUIDE TO TUNING SU CARBURETTERS

There are four distinct phases to tuning SU carburetters (carbies). The first is to set the fuel level in the float bowl, the second is to centre the needle in the jet, but only with fixed needles, not spring loaded ones, the third is to balance twin carbies. This step is not needed with a single carby, and the fourth and last is to set the air / fuel ratio.

I will discuss each phase separately.

### Setting of the fuel level.

SU's specification for the fuel level in the carby is 3/8 inch below the bridge.

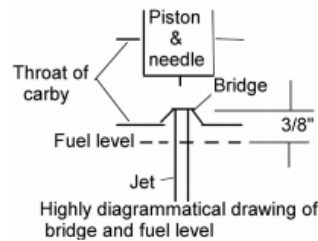

The level is adjusted in one of two ways. With the earlier and the latest floats the metal hinge is bent up or down to get the desired fuel level. With the all plastic floats washers are added or subtracted from under the needle valve to raise or lower the fuel level, more washers give a lower fuel level. When bending the hinge, be careful that the float doesn't hit

the inside of the bowl, when assembled.

The manuals say to use a rod of 1/8" diameter between the float and the edge of the cover, when held upside down. SU specifies this gap as anywhere from 1/8" to 7/16". I have found that 1/8" is too rich and the best way to arrive at this distance is to remove the vacuum chamber and piston, so that you can see the top of the jet. Pull out the choke, so that the jet is 3/8" down. Then adjust the fuel level, in one of the above ways, till the fuel is visible just below or level with the top of the jet. Now measure the gap of the float to the lid, for future reference. On my carbies I have found this to be 7/16". When the float has been adjusted replace the lid on the float bowl.

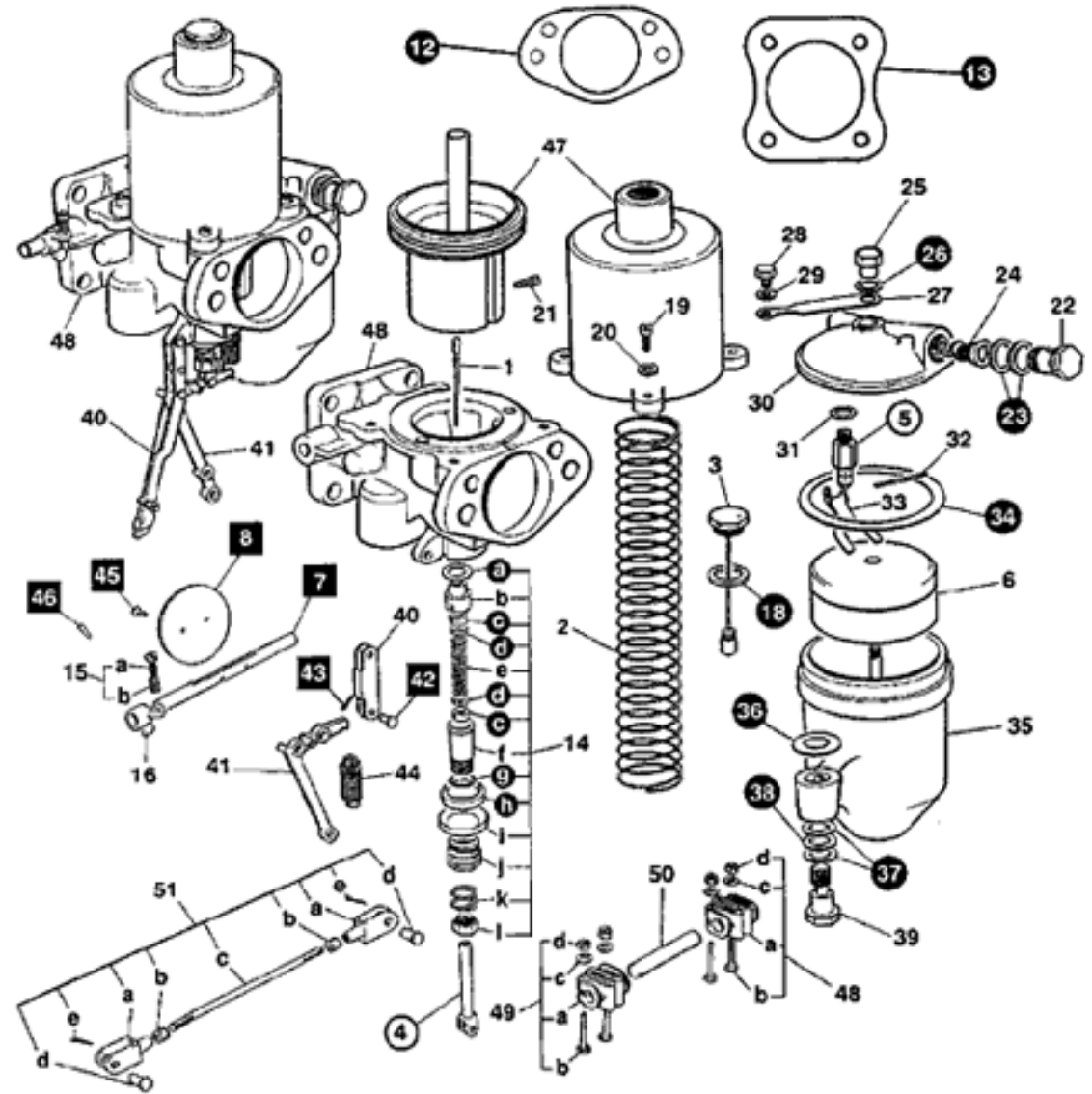
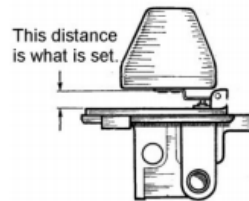

## Centering the jet

First determine if your jet(s) need centering. To do this, remove the piston dampers and the air cleaners, so you can access the pistons. Now with your finger "flip" the piston up and let it fall back. If it lands with a clunk, the jet is correctly centered. If it doesn't then the jet needs to be centered.

I know of two ways to achieve this.

Remove the vacuum chamber and piston and lower the metering needle, in the piston, by about 2 – 3mm.

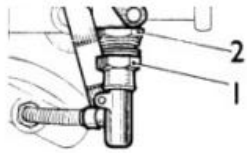

Slacken the jet locking nut, #2. With the jet fully raised, (no choke), reassemble the piston and chamber. The piston should now be slightly up from the bridge, i.e. the needle is sitting tight on the jet. Wiggle the jet assembly a bit to ensure that the needle is down as far as possible. Carefully tighten the locking nut,

return the needle to its correct position in the piston, the shoulder of the needle should be level with the bottom of the piston, and repeat the drop test. You may need to repeat this process, until the drop test is successful.

Oh, by the way the locking nut is Whitworth.

The second method is to use the centering pin from the SU tuning tool set.

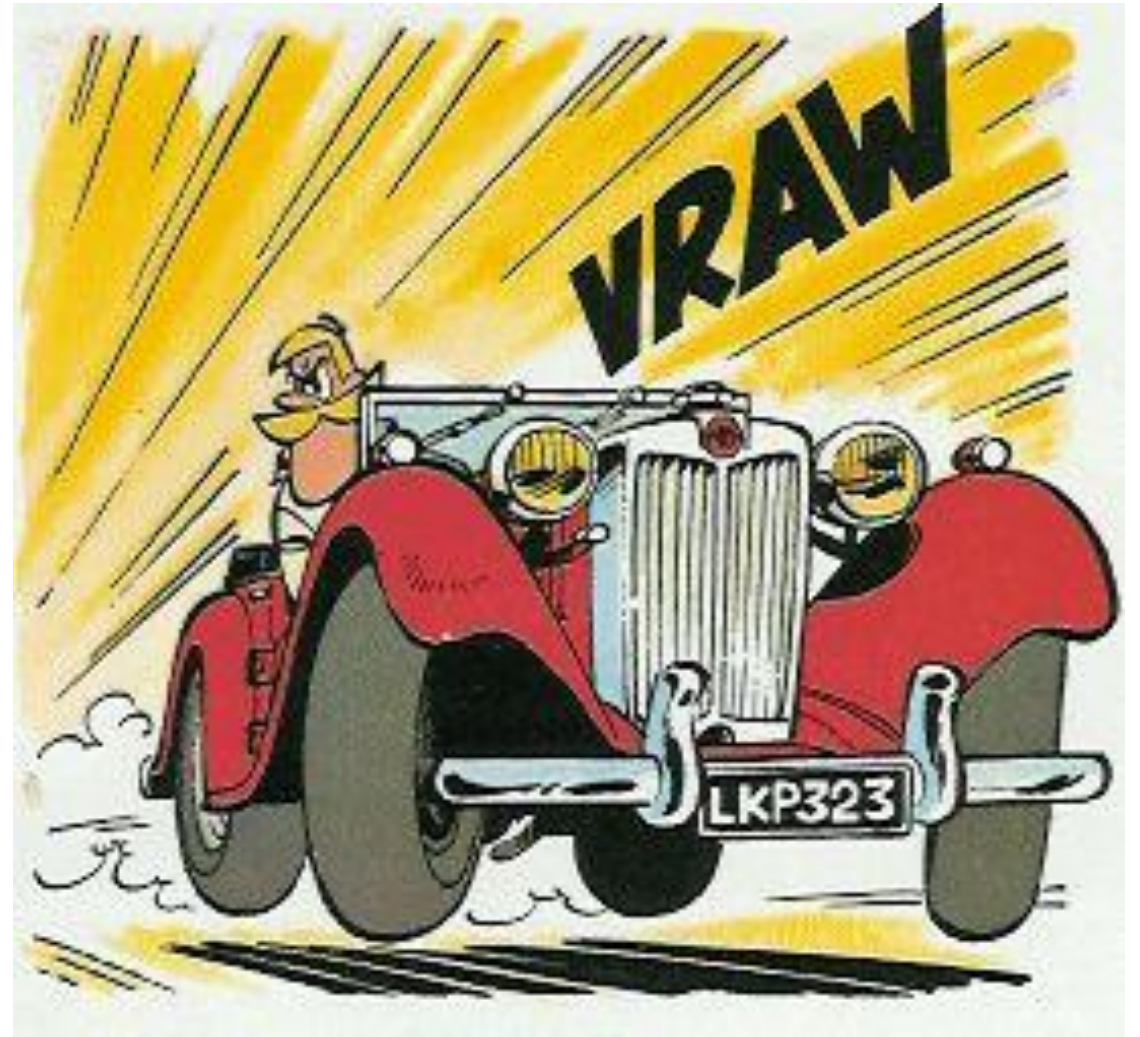

Rather than labouriously typing the instructions, I will simply copy them from the tool set.

**Centering the jet:** Remove suction chamber with piston and replace the jet needle with the centering pin. Lower (or remove) the jet to the lowest position and slacken the jet locking nut. Refit the chamber and piston, slide the centering pin into the jet bearing and tighten the locking nut. If the piston cannot be moved with the centering pin in the jet bearing, slacken the locking nut again and repeat the procedure until the centering pin can be moved in and out of the jet bearing. This insures that the jet needle is not touching the jet and that the piston is moving freely in the suction chamber.

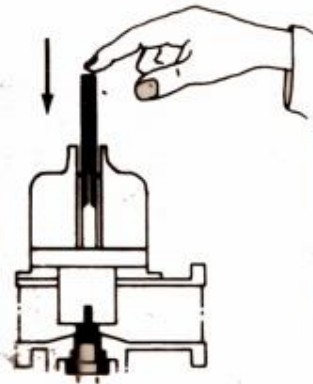

I have never used this method, mainly because I couldn't figure out how the centering pin fitted the jet. Duhhhh! I should have read the instructions. The old motto applies:-

"When all else fails, read the manual!"

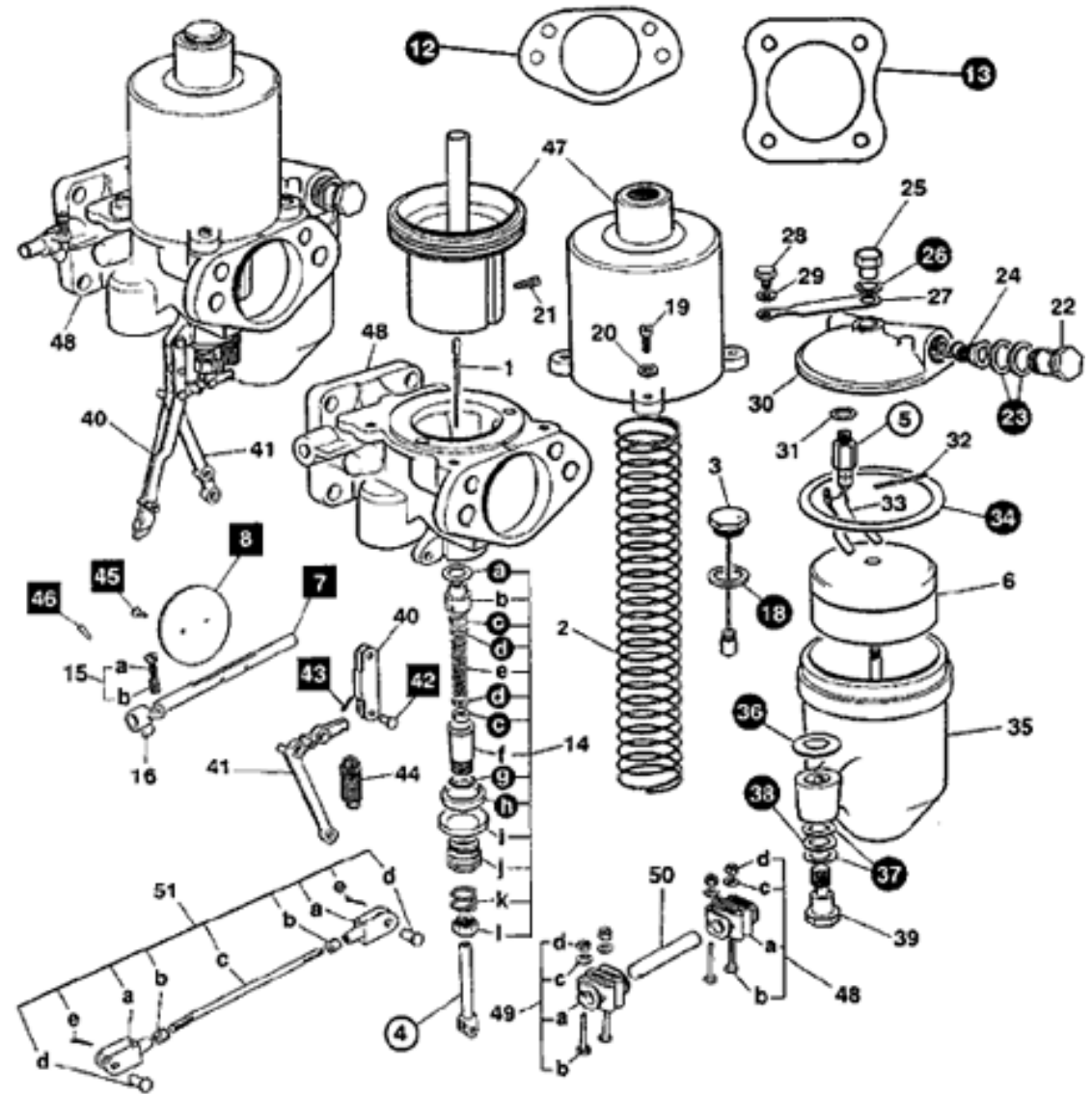

## An Idiot's Guide to tuning SU carbies

### Balancing twin carbies.

I know of at least four different ways to balance twin (more) carbies. Common with all methods is to loosen the throttle disk linkages between the carbies, so that each can be individually adjusted and remove the air filters.

The first method is probably the simplest, but with unknown accuracy. With the links "disconnected" back off the idle screws and ensure that all throttle disks are fully closed, then tighten up the linkages. I told you it was simple. Reset the idle speed by turning each idle control screw till the desired revs are reached. Note that both idle screws need to be adjusted, the same amount.

The second method is to start the engine, allow to reach operating temperature and use a small hose to listen to the suction hiss of each carbie and adjust the individual idle screws until both carbies sound the same. Good one for us oldies with compromised hearing.

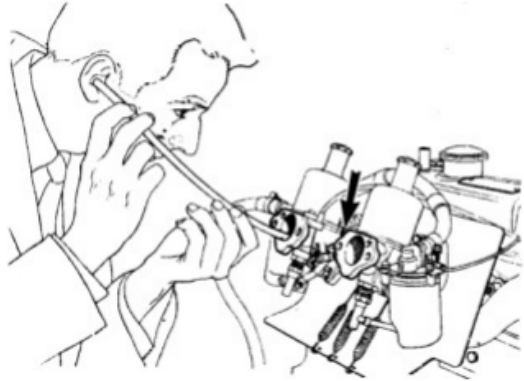

The third method is to use a device called a Unisync, which is basically an air flow meter.



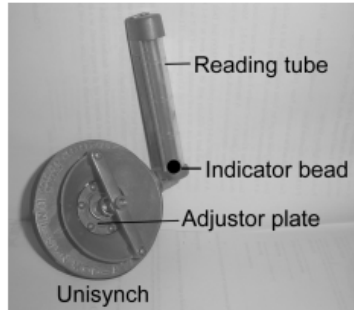

How this device works is that you tightly hold it against the input throat of one of the carbies, adjust the "adjustor" plate until the indicator bead is about half way up the reading tube. Then you place it against the other carbie and adjust the idle screw until the bead is in the same place, up the tube, as on the first carbie. Repeat until both carbies remain at the same setting.

Using an airflow meter is the optimum way to set the carbies. Now if you consider the SU carbie to, inherently, be an air flow meter, after all it's job is to meter fuel into the engine, depending on the amount of air being inducted, then the fourth method becomes ideal. To my way of thinking it is one of the cheapest, most accurate and hence the best way to balance the SU carbies.

Remove the dampers from the dashpots, take two pieces of soft wire (so they don't scratch the insides) bend them, as shown, the zig zag part is so that they are tight in the tube and don't wiggle about, insert into them into the dashpot tubes and adjust till they are both level, then start the engine and allow it to reach operating temperature. Now you adjust the idle screws on the carbies, till the wire ends are again level. Lock the linkage and Bob's your uncle. You can test the engine over a wide rev range and the ends should remain level.

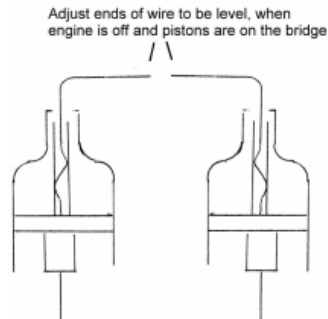

## Part 4

Herb Adler

OK, now the mechanical side of the carbies is set up, the final step, of setting the air / fuel ratio (AFR) needs to be done. This is achieved by moving the jet up or down, up for leaner, down for richer. I don't have an AFR meter, and assume most of you don't either, so the following is how you can do it without an AFR meter.

To start with you need to remove the air cleaners, vacuum chamber(s) and piston(s).

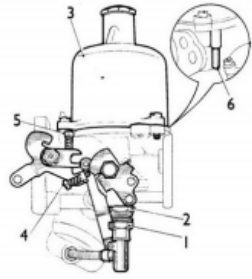

Turn the jet adjusting screw, 1, until the top of the jet is level with the bridge. This can be determined by using the end of a steel rule, or similar, placed across the top of the jet and bridge. Now mark the adjusting screw and the carb body, to have a starting reference. I have a little bottle of white appliance touch up acrylic paint, that I use. Do this on all carbies. Now turn the adjusting screw, 12 flats or 2 full turns, to move the jet down. This is where the marking comes in handy, you count the flats

as you turn. Reassemble the piston(s) and vacuum chamber(s), making sure that you don't mix them up, with multiple carbies.

Start the engine and allow it to warm up to operating temperature. Push in the choke.

When you push up on the piston lifting pin, 6, the engine will increase its revs, because it is rich. The correct mixture point is when the engine speeds up slightly and then drops back in revs. I used to be able to pick this point aurally, but now that my ears aren't what they were I can't, so I use a shop tachometer. A lean mix cause the engine to die.

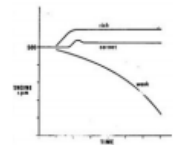

As you adjust one carb, do it by one flat at a time, and do the same on the other carb, so that they are in sync. When you have the correct point on the first carb, then lift the piston on the other carbs and fine tune that one. The go back to the first carb and check and adjust, if necessary.

Another method, that I use on my car, is to use a Gunson Colour Tune. This is basically a glass spark plug, that allows one to see the colour of the combustion. Yellow is rich, blue is good and light blue is lean. Colour

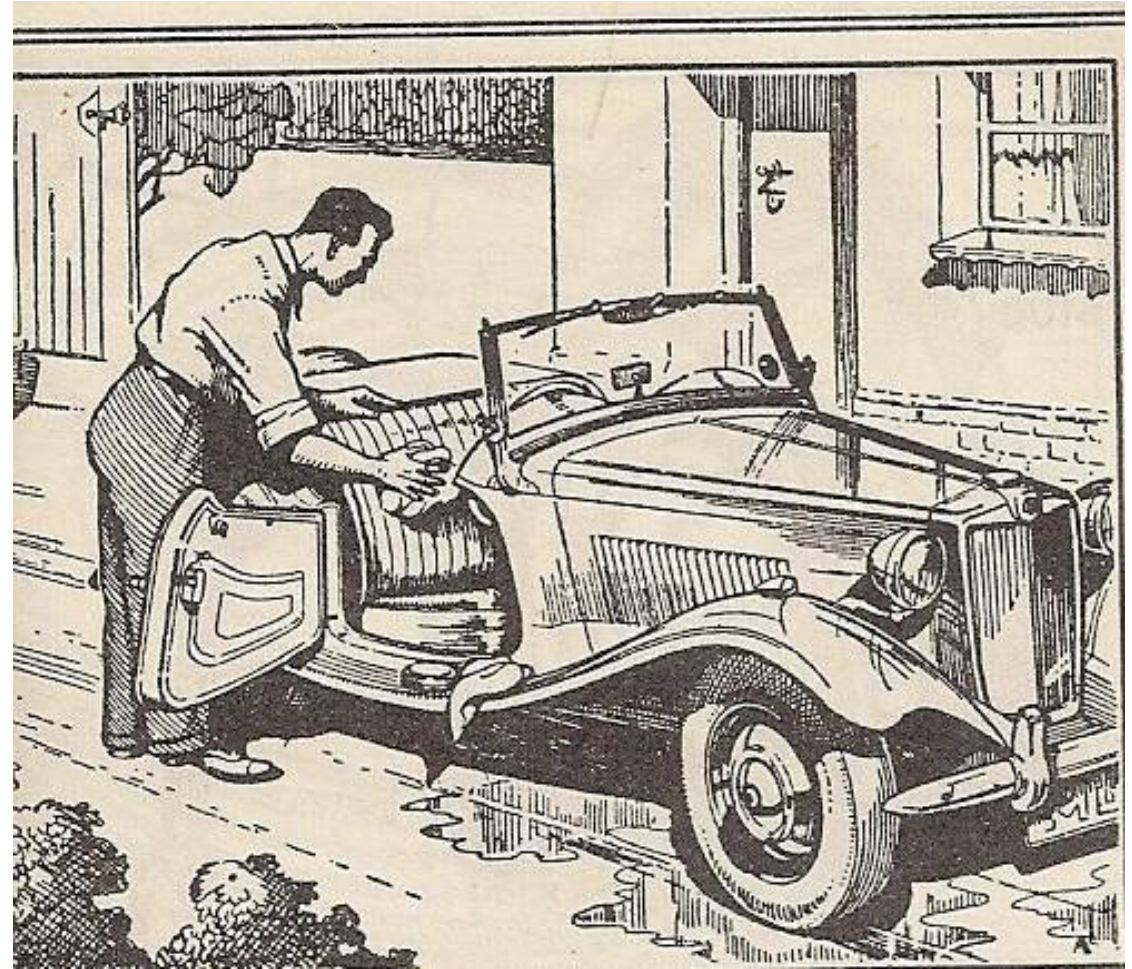

Tunes seem to be contrary, these days, with modern fuels. On my car they work great, but on a mate's car they showed yellow all the way to stalling the engine, by being too lean. I used the tacho method instead. Replace the air cleaner(s) and go for a long hard drive, up and down a freeway. If there is popping from the exhaust, when you take your foot off the accelerator, the engine is a bit too lean. After you get home and the engine has cooled a bit turn the jet adjusting screws down a half flat to slightly richen the mix. After driving the car for a while remove the spark plugs and check their colour. If they are a biscuit tan then your AFR is correct. White and it is a bit lean and grey to black too rich.

#### References

MGB workshop manuals, Haynes or Bentleys, downloadable from here:-

<http://www.bmcno.org/manuals/MGB%20Workshop%20Manual.pdf>

Tuning S.U. Carburettors, downloadable here:-

[http://mgaguru.com/mgtech/books/pdf/Tuning\\_SU\\_Carburetors.pdf](http://mgaguru.com/mgtech/books/pdf/Tuning_SU_Carburetors.pdf)

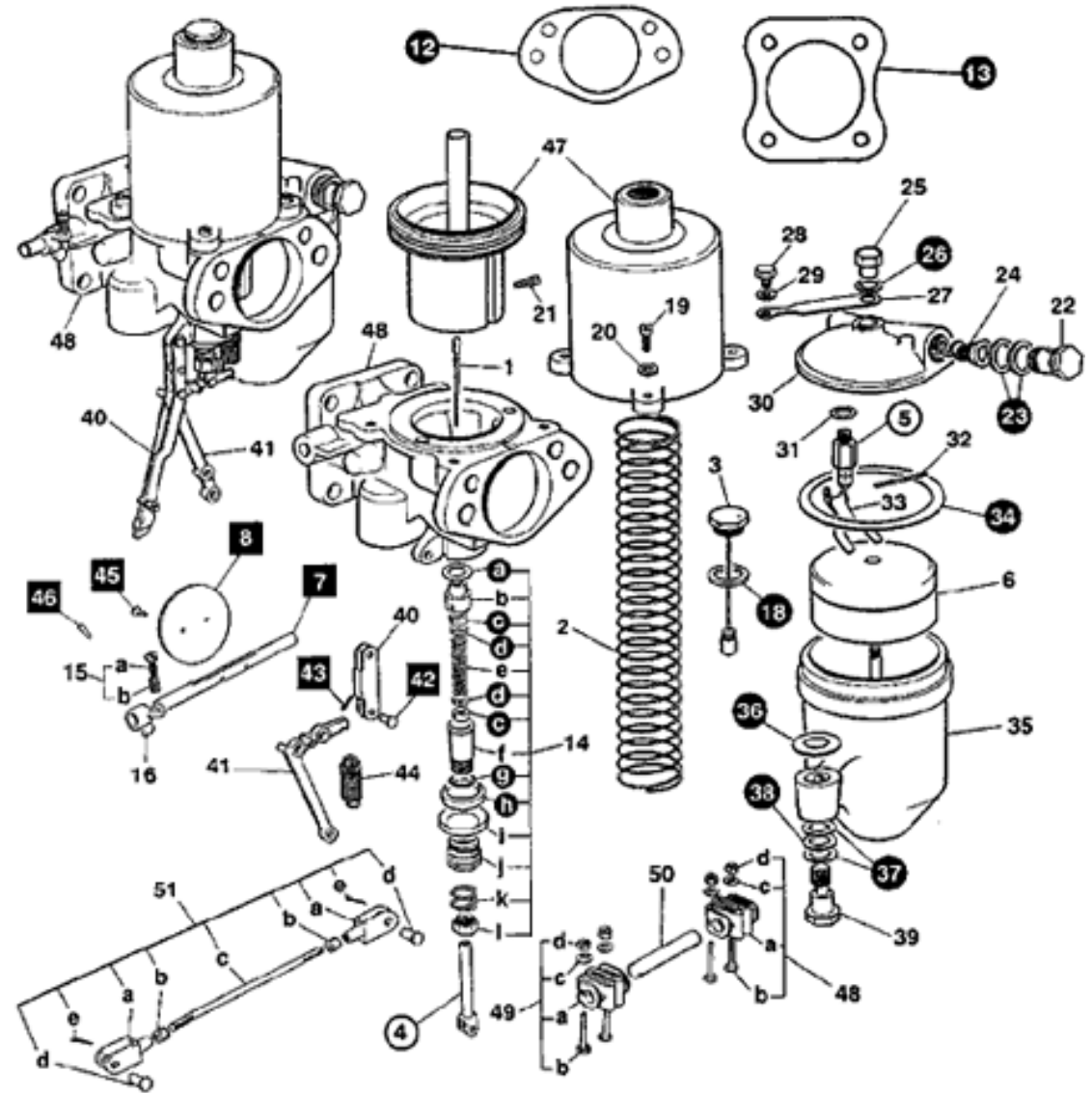



# Spark Tester

**TUDOR**



*Accu*